

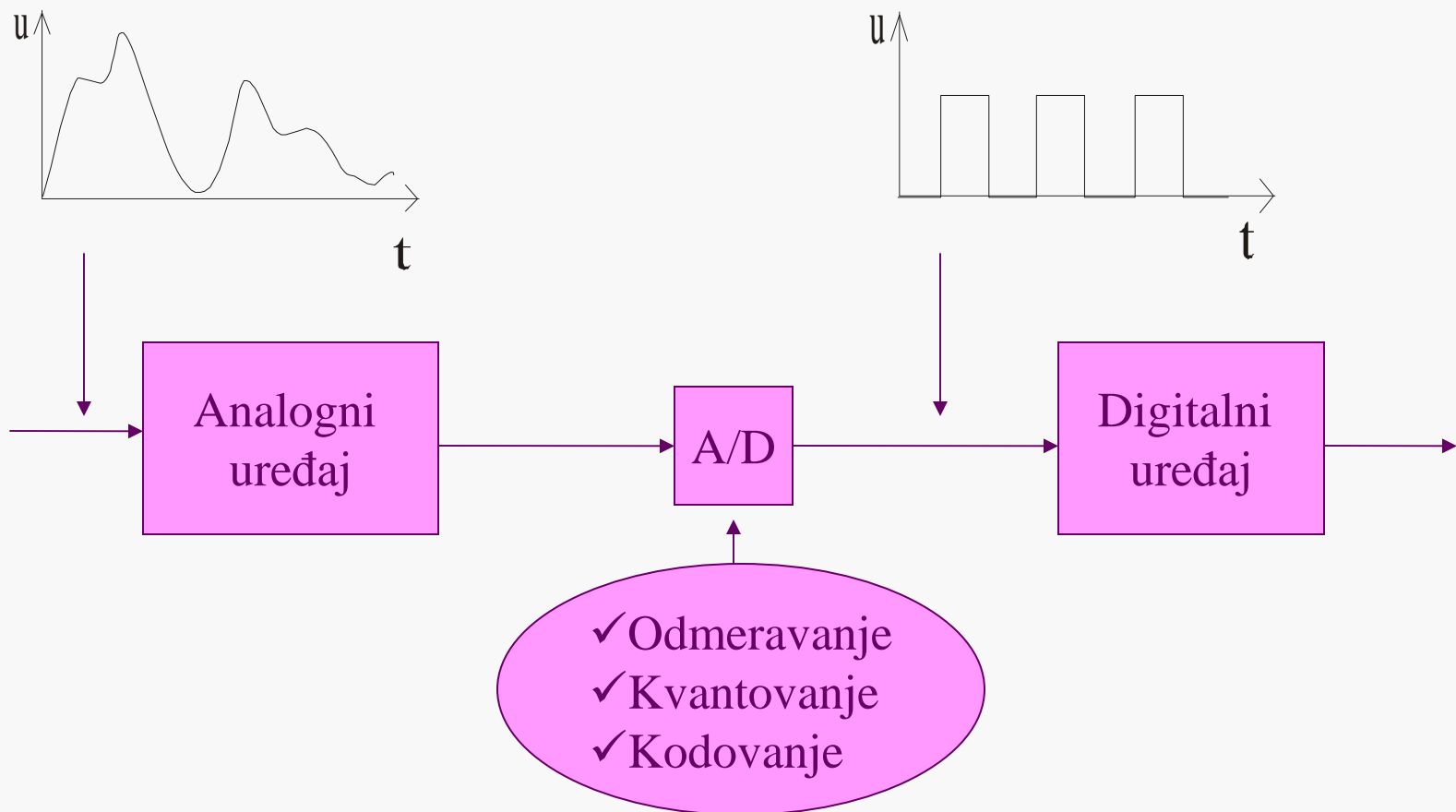

ELEKTRONIKA U ENERGETICI

Logička kola

Kontinualne i diskretne promene



Binarni sistem

{0, 1}

Kodovanje informacija vrši se u binarnom sistemu

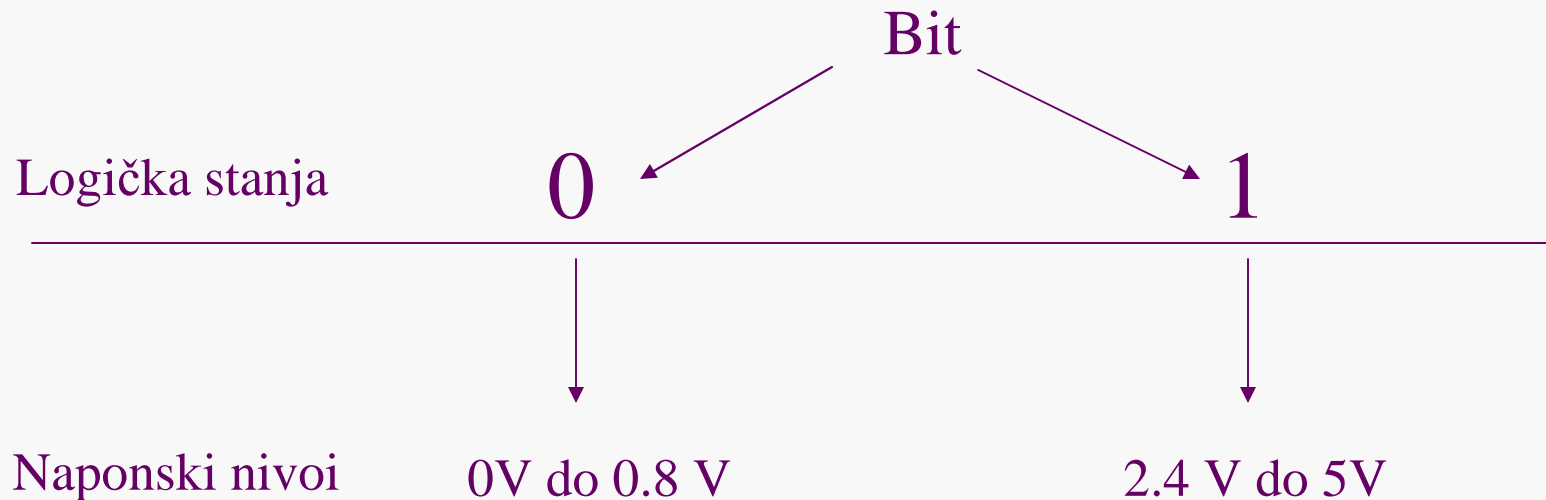

Digitalna informacija od 8 bita je 1 Bajt → 10010110

1 0 0 1 0 1 1 0

Bulova algebra

Nad bitovima (0 1) logička kola vrše operacije matematičke logike:

- logičko množenje (\cdot)
- logičko sabiranje (+)
- negacija ($\bar{}$)

Logičko množenje

$$0 \cdot 0 = 0$$

$$0 \cdot 1 = 0$$

$$1 \cdot 0 = 0$$

$$1 \cdot 1 = 1$$

Logičko sabiranje

$$0 + 0 = 0$$

$$0 + 1 = 1$$

$$1 + 0 = 1$$

$$1 + 1 = 1$$

Negacija

$$\bar{0} = 1$$

$$\bar{1} = 0$$

Logičko kolo I

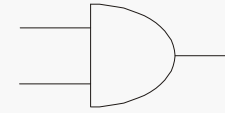

I kolo realizuje logičku operaciju množenja

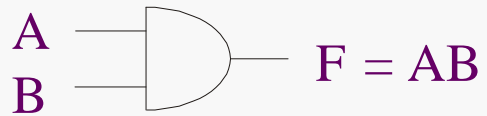

A	B	F
0	0	0
0	1	0
1	0	0
1	1	1

Tabela istinitosti

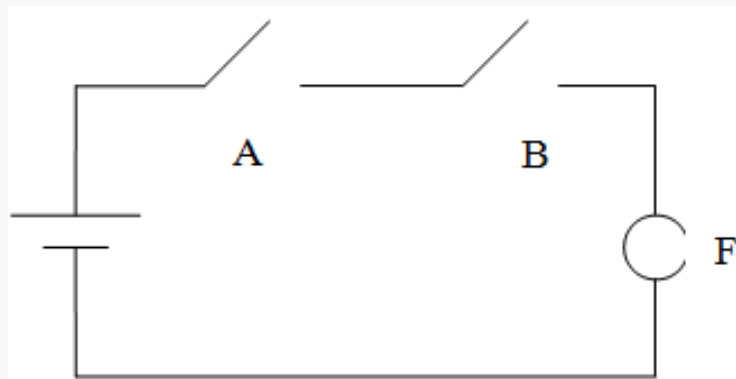
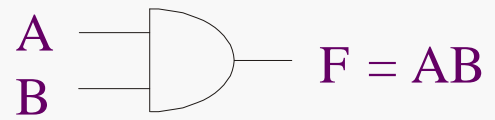

Ekvivalentna električna šema I kola

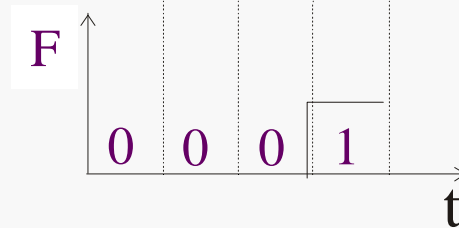
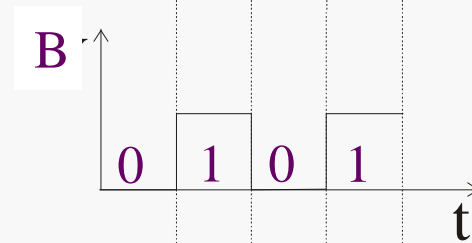
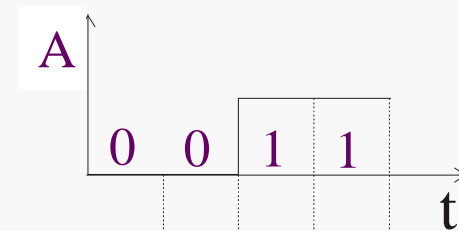

Vremenski dijagrami

Logičko kolo ILI

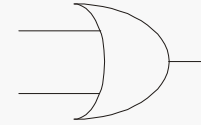

ILI kolo realizuje logičku operaciju sabiranja



A	B	F
0	0	0
0	1	1
1	0	1
1	1	1

Tabela istinitosti

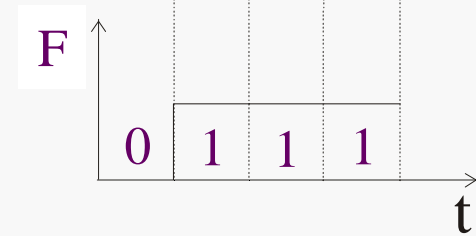
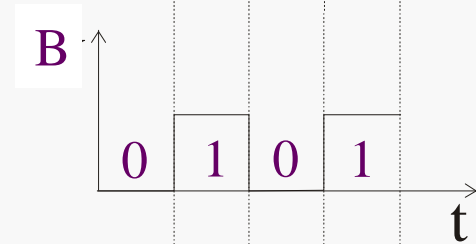
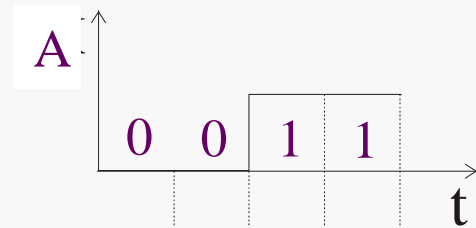
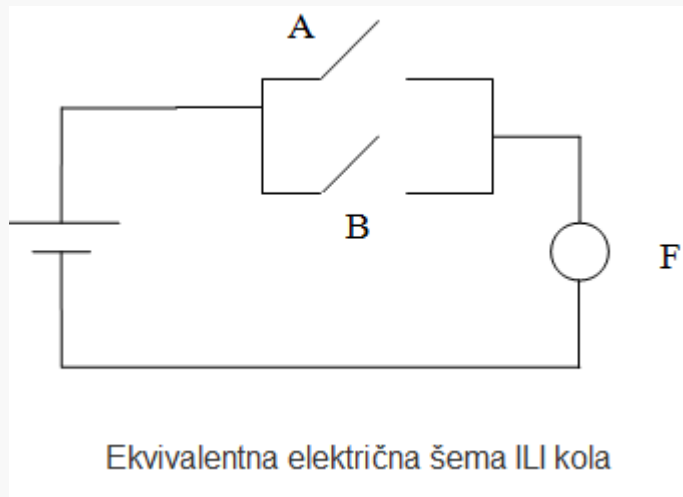

Vremenski dijagrami

Logička kola NE

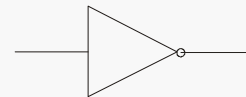

NE kolo realizuje logičku operaciju negacije

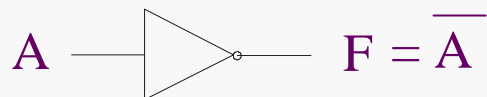

A	\overline{A}
0	1
1	0

Tabela istinitosti

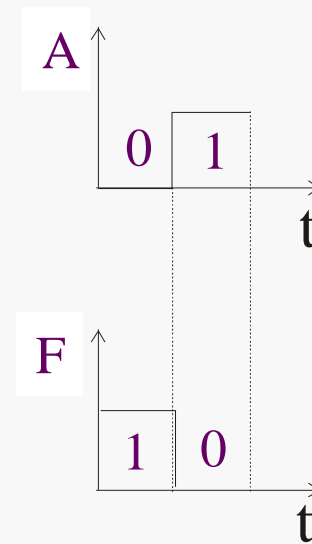
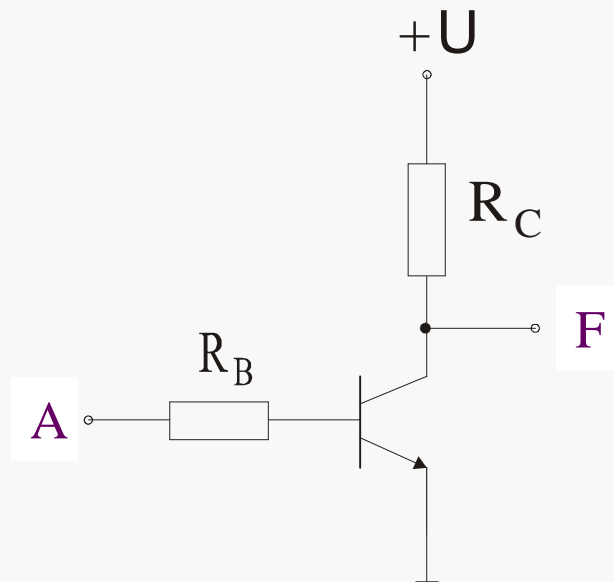
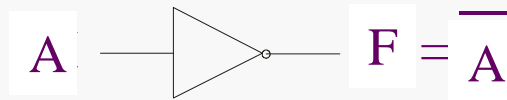

Električna šema NE kola

Vremenski dijagrami

Logičko kolo NI

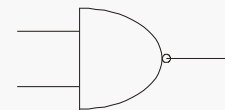

NI kolo realizuje negaciju logičke operacije množenja

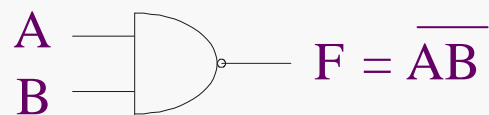

A	B	F
0	0	1
0	1	1
1	0	1
1	1	0

Tabela istinitosti

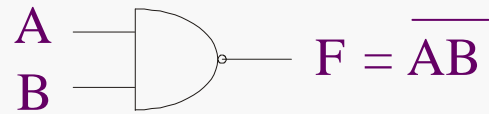

NI kolo je I kolo sa dodatim NE kolom

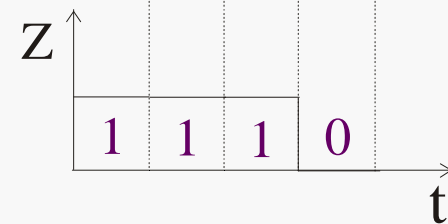
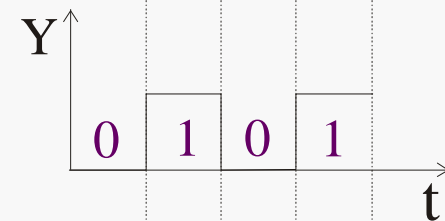
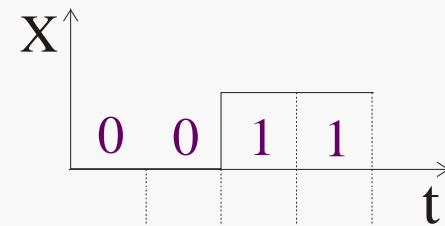
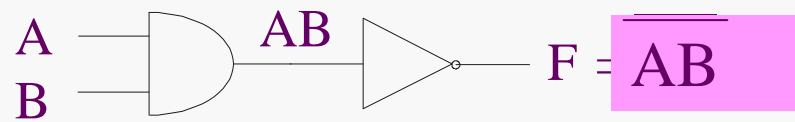

Vremenski dijagrami

Logičko kolo NILI

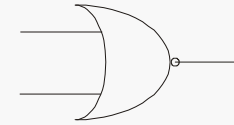

NILI kolo realizuje negaciju logičke operacije sabiranja



A	B	F
0	0	1
0	1	0
1	0	0
1	1	0

Tabela istinitosti

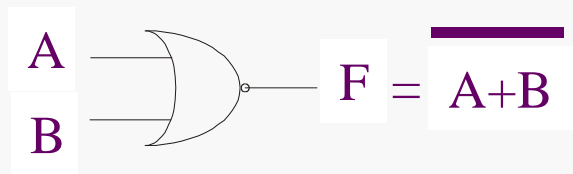

NILI kolo je ILI kolo sa dodatim NE kolom

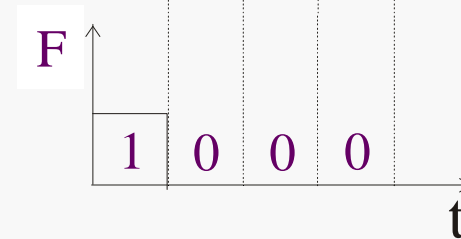
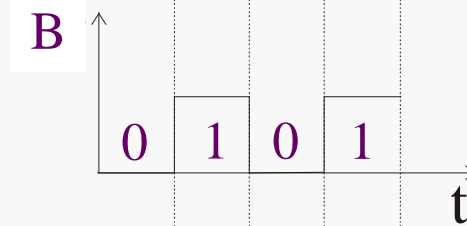
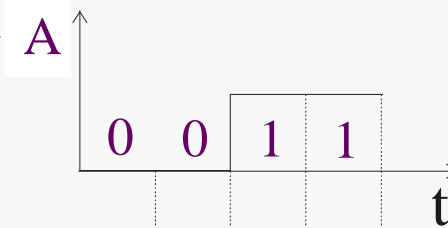
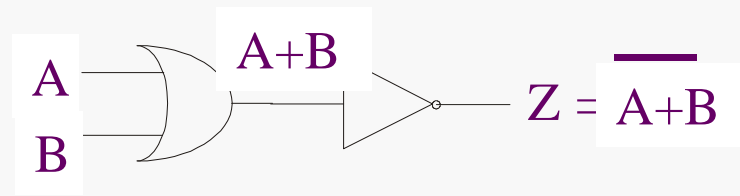

Vremenski dijagrami